

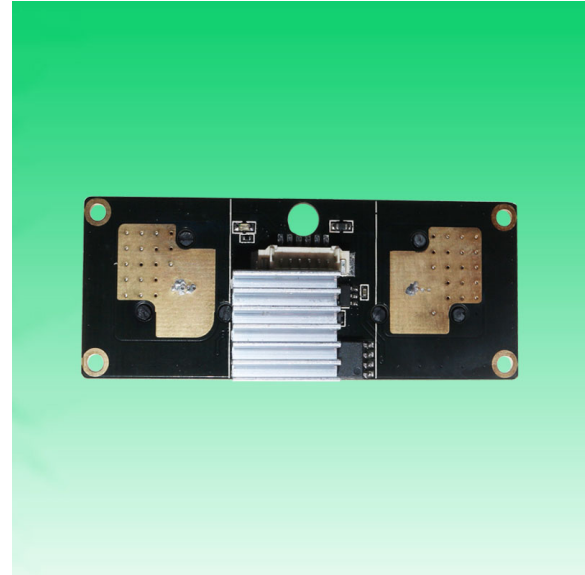

**KLT-USB1A-OV7251 V1.0 IR940**  
**0.3MP OmniVision OV7251 Global Shutter 940nm IR Pass**  
**Fixed Focus USB 2.0 Camera Module**



Front View



Back View

KLT-USB1A-OV7251 V1.0 IR940 is a 0.3MP Fixed Focus USB camera module based on 1/7.5" OV7251 global shutter image sensor. It delivers high-speed, VGA resolution monochrome (black and white) clear image. The S-mount lens holder enables customers to choose different lens as per varies applications. This camera module is ideal solution for face recognition, identity detection, automotive, access control.

### Key Features

- VGA resolution (640 x 480) OmniVision OV7251 global shutter sensor
- LED illumination
- High speed USB 2.0 Plug and Play
- MJPEG output format
- Low power consumption
- Compact size
- UVC compliant to Windows, Linux, OS with UVC driver
- USB OTG (On-The-Go) support



## KLT-USB1A-OV7251 V1.0 IR940

**0.3MP OmniVision OV7251 Global Shutter 940nm IR Pass  
Fixed Focus USB 2.0 Camera Module**

Camera Module No.	KLT-USB1A-OV7251 V1.0 IR940
Resolution	0.3MP
Image Sensor	OV7251 Global Shutter
Sensor Type	1/7.5"
Pixel Size	3.0 um x 3.0 um
EFL	1.84 mm
F.NO	2.55
Pixel	640 x 480
View Angle	100.0°(DFOV)
Lens Dimensions	8.00 x 8.00 x 12.52 mm
Module Type	Fixed Focus with LED
Interface	USB 2.0
Output Format	MJPEG
Auto Control	Saturation, Contrast, Acutance White Balance, Exposure
Audio	None
Input Voltage	DC 5V
Working Current	Max 500mA
PCB Size	60.00 x 23.50 mm
System Compatibility	Windows XP (SP2, SP3), Vista, 7, 8, 10, 11 Android, Mac OS, Linux or OS with UVC Driver Raspberry Pi by USB Port
Software for USB Camera	AMCAP, Webcam Viewer, V4L2 Controls Contacam, VLC Player, MotionEye OS iSpy, ZoneMider, Yawcam
Lens Type	650nm IR Cut and 940nm IR Pass
Operating Temperature	-30°C to +70°C
USB Cable	USB Cable

Wide Compatibility with Windows, Android, Mac OS, Linux, or Raspberry Pi





**KLT-USB1A-OV7251 V1.0 IR940**  
**0.3MP OmniVision OV7251 Global Shutter 940nm IR Pass**  
**Fixed Focus USB 2.0 Camera Module**



Top View

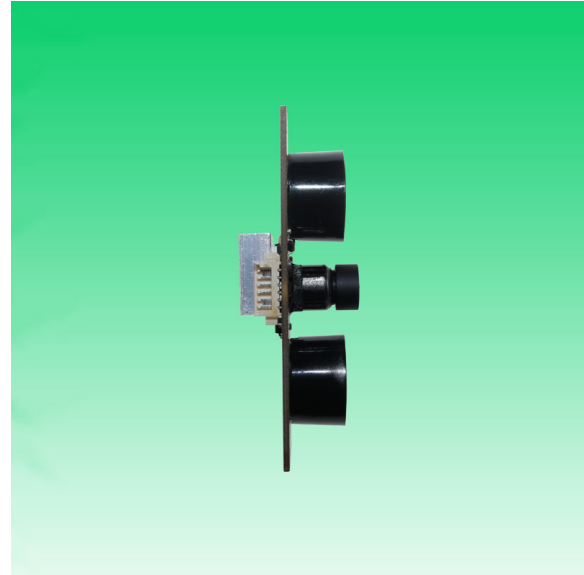

Side View



Bottom View



USB Cable

Version Mark	Information	Date
V1.0	PD First Version	2018-12-30

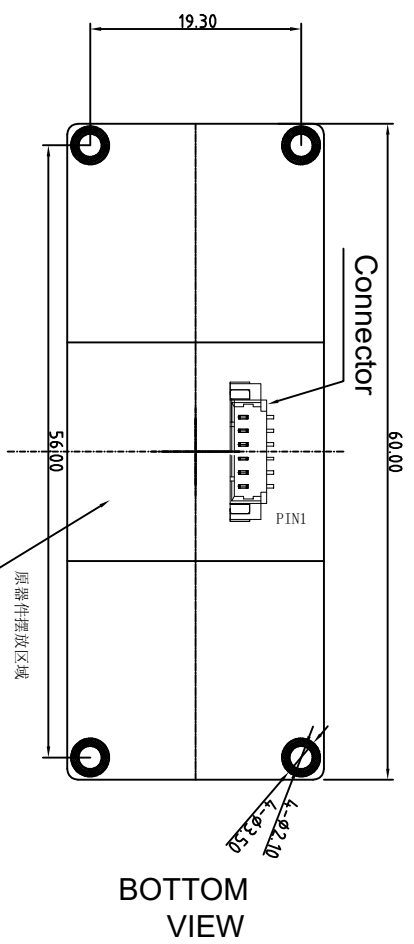
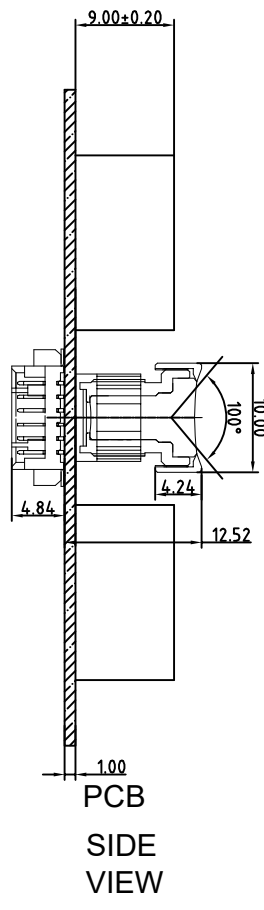
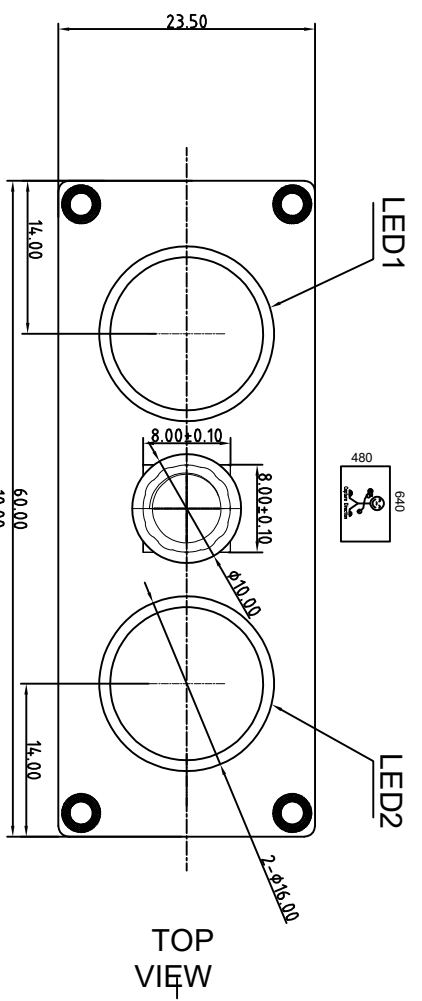

PIN NO	SIGNAL
PIN1	USB 5V
02	D-
03	D+
04	GND
05	LED-
06	LED+

Parameters:  
2、Sensor specification:

Image Sensor: 0V7251  
Pixel: 3um×3um  
Lens Type: 1/7.5

1、Lens specification:

FOV: 100°  
F/NO.: 2.55  
TV distortion: <-13.5%  
Focal length: 1.84mm  
Composition: 5G+IR FILTER  
IR Cut Coating: 940nm±10nm@50%

Kai Lap Technologies Group Ltd

Designed By Kevin

Checked By Aouly Yan

Model Name: KLT-USB1A-0V7251 V1.0 IR940

Projection Type: Third Angle  
Unit: mm  
Material:   
Scale: 1:1  
Sheet: 1 of 1  
Version: 1/0

A B C D E

3

3

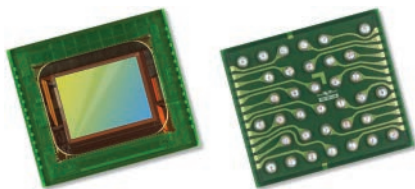

# OV7251 VGA product brief



## Low Power and Compact CameraChip™ Sensor with Industry's Smallest Global Shutter Pixel



available in a lead-free package

The OV7251 is a small form factor, low power CameraChip™ sensor that uses a global shutter to reduce or eliminate unwanted image artifacts, which occur with traditional rolling shutter image sensors as a result of motion during image capture. The sensor's global shutter and excellent low-light sensitivity allow it to be used for any application that has a need for gesture detection, head and eye tracking, and depth and motion detection.

The OV7251's compact form factor makes it a highly attractive camera solution for space-constrained applications such as head-mounted displays, smartphones, tablets, notebooks and Ultrabooks. Likewise, the sensor's low-power consumption makes it an ideal dedicated gesture sensor for similar application areas.

Leveraging the industry's smallest global shutter pixel, the black and white OV7251 is capable of capturing VGA (640x480) resolution video at 120 frames per

second (fps), QVGA (320x240) at 180 fps with binning, and QQVGA (160x120) at 360 fps with binning and skipping. The OV7251's high frame rates make it an ideal solution for low-latency machine vision applications.

The 1/7.5-inch OV7251 features multiple low-power modes, including light sensing mode and ultra-low power standby mode. In light sensing mode, the OV7251 behaves like an Ambient Light Sensor (ALS), which wakes the sensor up from "sleep mode" only when a change in light has been detected. Similarly, in ultra-low power mode, the sensor can reduce the resolution and frame rates to further reduce power consumption.

Find out more at [www.ovt.com](http://www.ovt.com).



## Applications

- Computer Vision
- Gesture Recognition
- 3D Systems
- Feature Tracking

## Product Features

- improved shutter efficiency for machine vision applications
- integral 850 nm bandpass filter
- 3  $\mu\text{m}$  x 3  $\mu\text{m}$  pixel with OmniPixel<sup>3</sup>-GS technology
- automatic black level calibration (ABLC)
- programmable controls for:
  - frame rate
  - mirror and flip
  - cropping
  - windowing
- support output formats: 8/10-bit RAW
- support for image sizes:
  - 640 x 480
  - 320 x 240
  - 160 x 120
- fast mode switching
- supports horizontal and vertical 2:1 and 4:1 monochrome subsampling
- supports 2x2 monochrome binning
- one-lane MIPI serial output interface
- one-lane LVDS serial output interface
- embedded 256 bits of one-time programmable (OTP) memory for part identification
- two on-chip phase lock loops (PLLs)
- built-in 1.5V regulator for core
- PWM
- built-in strobe control

# OV7251

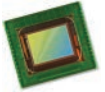

## Ordering Information

- OV7251-A35A-1G (b&w, lead-free, 35-pin CSP)
- OV7251-A35A-2B (b&w, improved PLS, lead-free, 35-pin CSP)
- OV7251-G04A-1G (b&w, reconstructed wafer with good die)
- OV7251-G04A-2B (b&w, improved PLS, reconstructed wafer with good die)
- OV7251-A35A-1J (b&w, lead-free, 35-pin CSP, black mask)

## Technical Specifications

- active array size: 640 x 480
- maximum image transfer rate:
  - 640 x 480: 120 fps
- power supply:
  - analog: 2.8V (nominal)
  - core: 1.5V (optional)
  - I/O: 1.8V (nominal)
- power requirements:
  - active: 119 mW @ 120 fps, VGA output
  - standby: 15  $\mu\text{A}$  for AVDD, 40  $\mu\text{A}$  for DOVDD without input clock, 700  $\mu\text{A}$  for DOVDD with input clock
  - XSHUTDOWN: 5  $\mu\text{A}$  for AVDD, 5  $\mu\text{A}$  for DOVDD
- output formats: 10-bit B&W RAW
- temperature range:
  - operating: -30°C to +70°C junction temperature
  - stable image: 0°C to +50°C junction temperature
- output interface: 1-lane MIPI/LVDS serial output
- lens size: 1/7.5"
- lens chief ray angle: 29° non-linear
- scan mode: progressive
- pixel size: 3  $\mu\text{m}$  x 3  $\mu\text{m}$
- image area: 1968  $\mu\text{m}$  x 1488  $\mu\text{m}$

## Functional Block Diagram

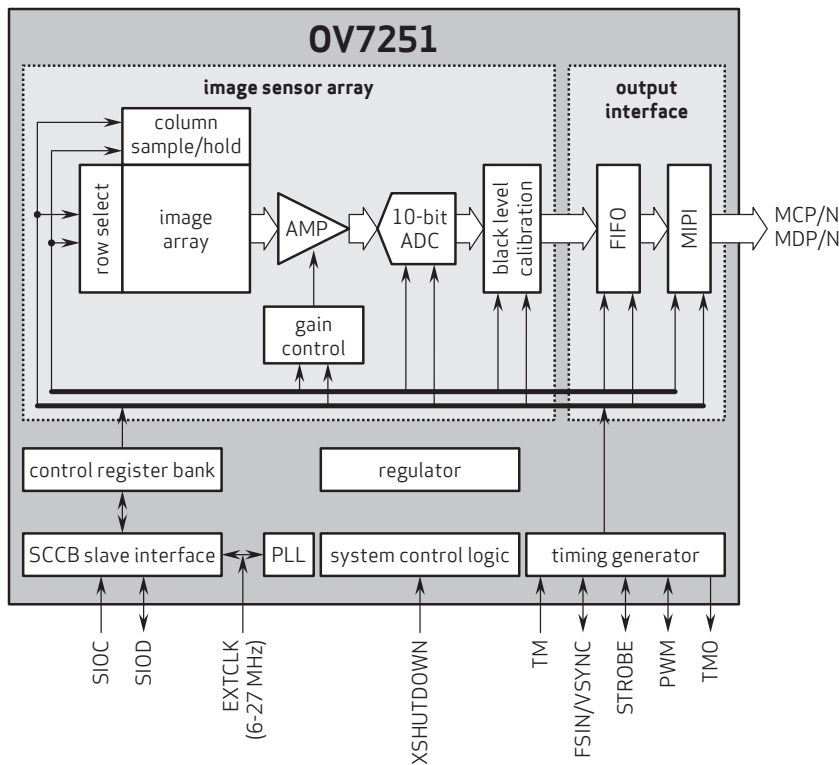

4275 Burton Drive  
Santa Clara, CA 95054  
USA

Tel: + 1 408 567 3000  
Fax: + 1 408 567 3001  
www.ovt.com

OmniVision reserves the right to make changes to their products or to discontinue any product or service without further notice. OmniVision, the OmniVision logo, and OmniPixel are registered trademarks of OmniVision Technologies, Inc. CameraChip is a trademark of OmniVision Technologies, Inc. All other trademarks are the property of their respective owners.



OmniVision

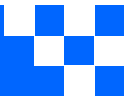

## Cameras Applications



Automotive Driver Pilot



Live Streaming



Video Conference



Eye Tracker Biometric Detection

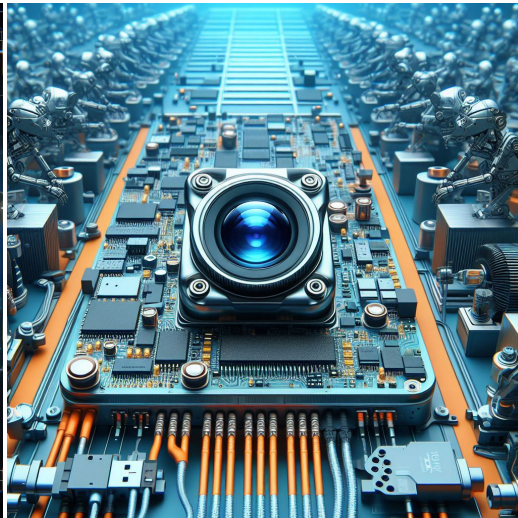

Machine Vision



Agricultural Monitor

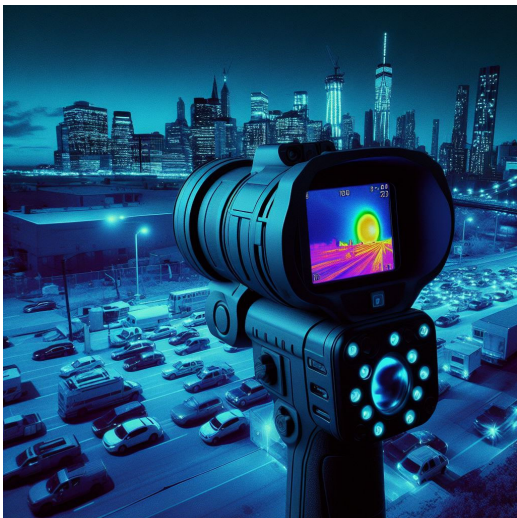

Night Vision Security



Drone and Sports Eagle Eyes



Interactive Pet Camera



your **BEST** camera module partner

## Cameras Applications







## Camera Module Pinout Definition Reference Chart

OmniVision	Sony	Samsung	On-Semi	Aptina	Himax	GalaxyCore	PixArt	SmartSens	Sensors
Pin Signal									
Description									
DGND	GND								
AGND									
PCLK	DCK								
XCLR	PWDN	XSHUTDOWN	STANDBY						
MCLK	XVCLK	XCLK	INCK						
RESET	RST								
NC	NULL								
SDA	SIO_D	SIOD							
SCL	SIO_C	SIOC							
VSYNC	XVS	FSYNC							
HREF	XHS								
DOVDD									
AFVDD									
AVDD									
DVDD									
STROBE	FSTROBE								
FSIN									
SID									
ILPWM									
FREX									
GPIO									
SLASEL									
AFEN									
<b>MIPI Interface</b>									
MDN0	DN0	MD0N	DATA_N	DMO1N					
MDP0	DP0	MD0P	DATA_P	DMO1P					
MDN1	DN1	MD1N	DATA2_N	DMO2N					
MDP1	DP1	MD1P	DATA2_P	DMO2P					
MDN2	DN2	MD2N	DATA3_N	DMO3N					
MDP2	DP2	MD2P	DATA3_P	DMO3P					
MDN3	DN3	MD3N	DATA4_N	DMO4N					
MDP3	DP3	MD3P	DATA4_P	DMO4P					
MCN	CLKN	CLK_N	DCKN						
MCP	CLKP	MCP	CLK_P	DCKN					
<b>DVP Parallel Interface</b>									
D0	DO0	Y0							
D1	DO1	Y1							
D2	DO2	Y2							
D3	DO3	Y3							
D4	DO4	Y4							
D5	DO5	Y5							
D6	DO6	Y6							
D7	DO7	Y7							
D8	DO8	Y8							
D9	DO9	Y9							
D10	DO10	Y10							
D11	DO11	Y11							

## Camera Reliability Test

Reliability Inspection Item		Testing Method	Acceptance Criteria	
Category	Item			
Environmental	Storage Temperature	High 60°C 96 Hours	Temperature Chamber	No Abnormal Situation
		Low -20°C 96 Hours	Temperature Chamber	No Abnormal Situation
	Operation Temperature	High 60°C 24 Hours	Temperature Chamber	No Abnormal Situation
		Low -20°C 24 Hours	Temperature Chamber	No Abnormal Situation
	Humidity	60°C 80% 24 Hours	Temperature Chamber	No Abnormal Situation
	Thermal Shock	High 60°C 0.5 Hours Low -20°C 0.5 Hours Cycling in 24 Hours	Temperature Chamber	No Abnormal Situation
Physical	Drop Test (Free Falling)	Without Package 60cm	10 Times on Wood Floor	Electrically Functional
		With Package 60cm	10 Times on Wood Floor	Electrically Functional
	Vibration Test	50Hz X-Axis 2mm 30min	Vibration Table	Electrically Functional
		50Hz Y-Axis 2mm 30min	Vibration Table	Electrically Functional
		50Hz Z-Axis 2mm 30min	Vibration Table	Electrically Functional
	Cable Tensile Strength Test	Loading Weight 4 kg 60 Seconds Cycling in 24 Hours	Tensile Testing Machine	Electrically Functional
Electrical	ESD Test	Contact Discharge 2 KV	ESD Testing Machine	Electrically Functional
		Air Discharge 4 KV	ESD Testing Machine	Electrically Functional
	Aging Test	On/Off 30 Seconds Cycling in 24 Hours	Power Switch	Electrically Functional
	USB Connector	On/Off 250 Times	Plug and Unplug	Electrically Functional





Inspection Item		Inspection Method	Standard of Inspection		
Category	Item				
Appearance	FPC/ PCB	Color	The Naked Eye	Major Difference is Not Allowed.	
		Be Torn/Chopped	The Naked Eye	Copper Crack Exposure is Not Allowed.	
		Marking	The Naked Eye	Clear, Recognizable (Within 30cm Distance)	
	Holder	Scratches	The Naked Eye	The Inside Crack Exposure is Not Allowed	
		Gap	The Naked Eye	Meet the Height Standard	
		Screw	The Naked Eye	Make Sure Screws Are Presented (If Any)	
		Damage	The Naked Eye	The Inside Crack Exposure is Not Allowed	
	Lens	Scratch	The Naked Eye	No Effect On Resolution Standard	
		Contamination	The Naked Eye	No Effect On Resolution Standard	
		Oil Film	The Naked Eye	No Effect On Resolution Standard	
		Cover Tape	The Naked Eye	No Issue On Appearance.	
	Function	Image	No Communication	Test Board	Not Allowed
			Bright Pixel	Black Board	Not Allowed In the Image Center
Dark Pixel			White board	Not Allowed In the Image Center	
Blurry			The Naked Eye	Not Allowed	
No Image			The Naked Eye	Not Allowed	
Vertical Line			The Naked Eye	Not Allowed	
Horizontal Line			The Naked Eye	Not Allowed	
Light Leakage			The Naked Eye	Not Allowed	
Blinking Image			The Naked Eye	Not Allowed	
Bruise			Inspection Jig	Not Allowed	
Resolution			Chart	Follows Outgoing Inspection Chart Standard	
Color			The Naked Eye	No Issue	
Noise			The Naked Eye	Not Allowed	
Corner Dark			The Naked Eye	Less Than 100px By 100px	
Color Resolution			The Naked Eye	No Issue	
Dimension	Height	The Naked Eye	Follows Approval Data Sheet		
	Width	The Naked Eye	Follows Approval Data Sheet		
	Length	The Naked Eye	Follows Approval Data Sheet		
	Overall	The Naked Eye	Follows Approval Data Sheet		



## KLT Package Solutions

KLT Camera Module

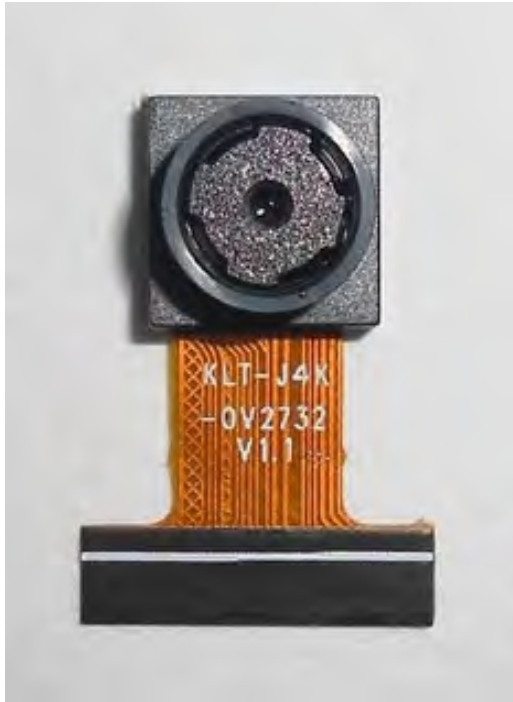

Complete with Lens Protection Film



Tray with Grid and Space



Place Cameras on the Tray

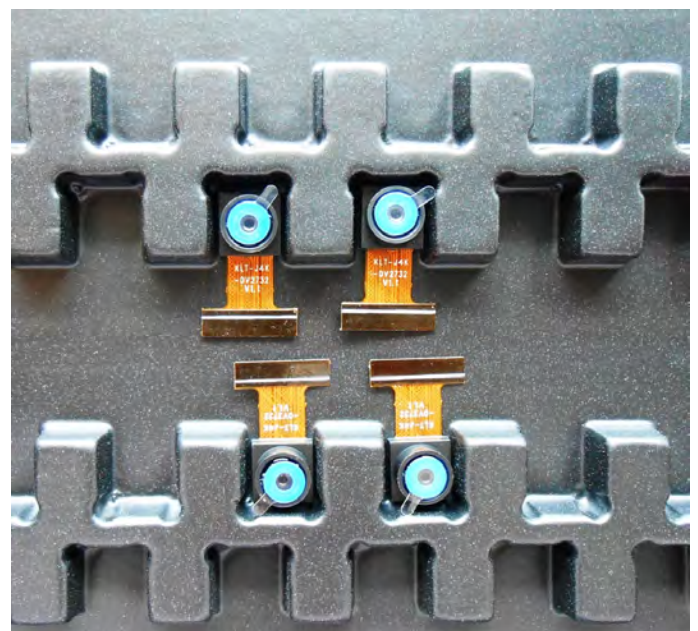

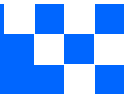

## Camera Modules Package Solution

Full Tray of Cameras

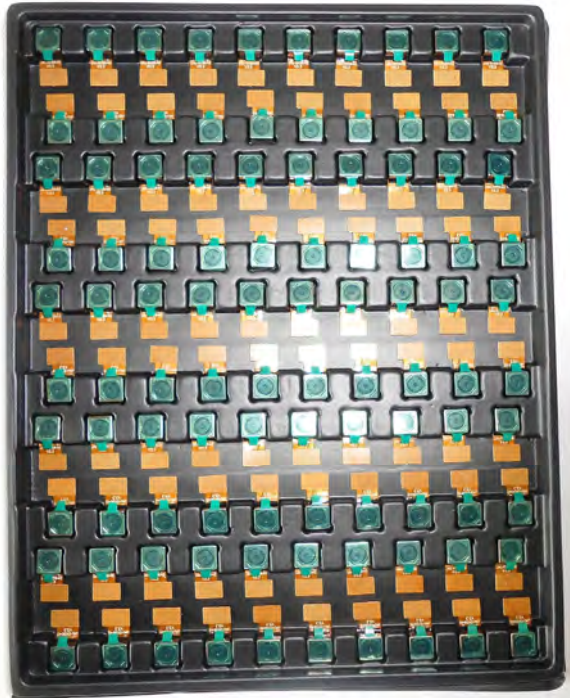

Cover Tray with Lid



Put Tray into Anti-Static Bag



Vacuum the Anti-Static Bag

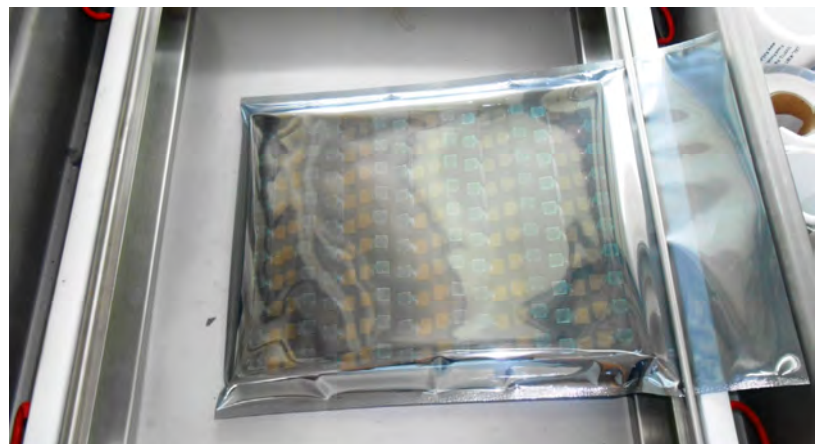



## Camera Modules Package Solution

### Sealed Vacuum Bag with Labels

1. Model and Description 2. Quantity 3. Shipping Date 4. Caution





## Large Order Package Solution

Place Foam Sheets Between Trays



Foam Sheets are Slightly Larger than Trays



Place Foam Sheets and Trays into Box



Foam Sheets are Tightly Fitting Box





## Small Order Package Solution

Place Foam Sheets and Trays into Small Box



Foam Sheets are Nicely Fitting the Small Box



Package in Small Box for Shipment



Place Small Boxes into Larger Box







*your BEST camera module partner*

## Carbon Box Package Solution

Seal the Carbon Box

Final Package Labelled Box



### Carbon Box Ready for Shipment

1. Delivery Address and Phone No. 2. Box No. and Ship Date 3. Fragile Caution





## Sample Order Package Solution

Place Sample into Small Anti-Static Bag



Place Connectors into Small Ant-Static Bag



### Sample Labels on the Small Bag

1. Camera Module or Connector Model 2. Shipping Date and Quantity 3. Caution





*your BEST camera module partner*

## Connectors Large Order Package Solution

Connectors in a Wheel



Label Connectors in the Wheel



The Wheel is Perfectly Fitting the Box



Connectors Box Ready for Shipment





## Company Kai Lap Technologies (KLT)

Kai Lap Technologies Group Limited. (KLT) was established in 2009, a next-generation technology driven manufacturer specialized in research, design, and produce of audio and video products. KLT is occupying 20,000 square feet automated plants with 100 employees of annual throughput 30,000,000 units cameras.

KLT provides OEM, ODM design, contract manufacturing, and builds the camera products. You may provide the requirements to us, even with a hand draft, our sales and engineering work together to meet your needs. We consider ourselves your last-term partner in developing practical and innovative solutions.

Our team covers everything from initial concept development to mass produced product. KLT specializes in customized camera design, raw material, electronic engineering, firmware/software development, product testing, and packing design. Our experienced strategic supply systems offer a robust and dependable manufacturing capacity for orders of various sizes.

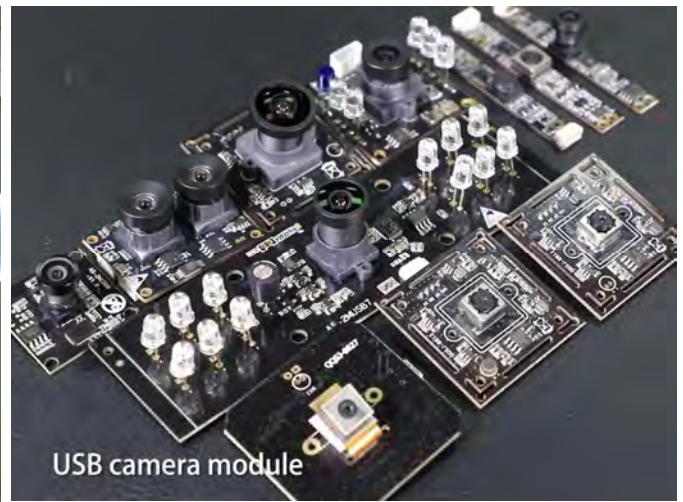

## Limited Warranty

KLT provides the following limited warranty if you purchased the Product(s) directly from KLT company or from KLT's website, [www.KaiLapTech.com](http://www.KaiLapTech.com). Product(s) purchased from other sellers or sources are not covered by this Limited Warranty. KLT guarantees that the Product(s) will be free from defects in materials and workmanship under normal use for a period of one (1) year from the date you receive the product ("Warranty Period").

For all Product(s) that contain or develop material defects in materials or workmanship during the Warranty Period, KLT will, at its sole option, either: (i) repair the Product(s); (ii) replace the Product(s) with a new or refurbished Product(s) (replacement Product(s) being of identical model or functional equivalent); or (iii) provide you a refund of the price you paid for the Product(s).

This Limited Warranty of KLT is solely limited to repair and/or replacement on the terms set forth above. KLT is not reliable or responsible for any subsequent events.





# CMOS CAMERA MODULES



*your BEST camera module partner*

## KLT Strength

### Powerful Factory



### Professional Service



### Promised Delivery



[www.KaiLapTech.com](http://www.KaiLapTech.com) [sales@KaiLapTech.com](mailto:sales@KaiLapTech.com) Tel: (852) 6908 1256 Fax: (852) 3017 6778

All rights reserved @ Kai Lap Technologies Group Ltd. Specifications subject to change without notice.